

# Elephant Robotics User Manual

## Catbot Series Collaborative Robot



Language: English

Version: CR0919001

## Copyright Declaration

No unit or individual may extract, compose, translate or reproduce any of the contents of this manual without the written permission of Shenzhen Elephant Robotics Technology Co., Ltd. (the rest of the article is referred to as “Elephant Robotics”), and shall not in any form (including But not limited to information and publications).

In addition, the product information and related resources mentioned in this manual are for reference only and the contents are subject to change without notice.

Except as expressly stated in this manual, nothing in this manual should be construed as any warranty or guarantee by the Elephant Robotics of personal loss, damage to property, or fitness for a particular purpose.

All rights reserved!

## Catalog

Overview to the manual .....	1
About the manual .....	1
Reading objects of the manual .....	1
How to use.....	1
Main contents of the manual .....	1
Before the official reading of the manual .....	2
1 Safety.....	3
1.1 Introduction.....	3
1.2 Safety alert symbol description.....	3
1.3 Hazard identification .....	4
1.4 Safety Precautions .....	6
1.5 Nameplate introduction.....	8
1.6 Avoid misuse .....	8
1.7 Risk assessment guidance .....	9
1.8 Robot stop function.....	9
1.8.1 Emergency stop .....	9
1.8.2 Collision detection .....	10
1.9 Urgent handling .....	11
2 Product description .....	12
2.1 Robot system overview .....	12
2.2 The robot body .....	13
2.2.1 Feature .....	13
2.2.2 Joint introduction .....	14
2.2.3 Dimensions.....	14
2.2.4 Working range .....	15
2.2.5 Payload .....	16
2.3 The power box.....	16
2.3.1 Power box composition .....	16
2.3.2 Power box function.....	16
2.3.3 Power box size .....	17
2.4 Technical parameter table .....	17
3 Environment and installation.....	20
3.1 Transportation and storage .....	20
3.2 Unpacking inspection .....	20
3.3 Working environment and conditions .....	22
3.4 Mechanical connection .....	23
3.4.1 Installation requirements .....	23
3.4.2 Mechanical connection step .....	23
3.5 Electrical connections.....	26
3.5.1 Electrical interface introduction .....	26
3.5.2 Cable connection.....	34
3.6 System startup debugging.....	35
4 Maintenance .....	37
4.1 About the safety of maintenance .....	37
4.2 Maintenance plan .....	38
4.3 People who can be contacted .....	38
5 Repair .....	40

# Overview to the manual

## About the manual

---

Welcome to use Catbot series collaborative robot and thanks for your purchase.

This manual describes how to properly install and use the Catbot series collaborative robot, as well as matters needing attention.

Please read this manual and other related manuals carefully before installing this robot system. After reading, please keep it in a safe place so that you can access it at any time.

## Reading objects of the manual

---

This manual is targeted to:

- Installer.
- Debugger.
- Maintenance staff.



**Attention**

Those who perform installation/debug/repair work on the Catbot series collaborative robot must be trained in Elephant Robotics and have the mechanical and electrical knowledge required for the above work.

## How to use

---

This manual should be used when doing the followings:

- Installation work: Move the robot to the working position and fix it to the base according to the installation instructions, place the other parts in the proper position and complete the electrical connection.
- Debugging work: Debug the robot to work.
- Maintenance work: Regularly maintain the robot system to ensure its can function properly; when the robot malfunctions due to environmental influences or improper operation of the user, or a certain component of the robot system exceeds the normal service life, etc. The robot needs to be repaired.

## Main contents of the manual

---

- Precautions for safe use of the robot.
- Mechanical, electrical installation and commissioning of the robot.
- Maintenance and repair of the robot.

---

## Before the official reading of the manual

---

Before you officially read the manual, you need to know:

### 1, About robots

The Catbot series collaborative robot is different from the traditional industrial robot, which completes the perfect slimming of the robot and realizes the cabinet integration. It can work safely with workers and independently complete the processes of loading, unloading, testing, checking and packaging in industrial manufacturing.

### 2, About product warranty

During the warranty period of the delivered product, the company only repairs the faults that occur when the robot is used normally. However, in the following cases, the customer will be charged for repairs (even during the warranty period):

- 1) Damage or malfunction caused by incorrect use of the contents of the manual and improper use.
- 2) Failure caused by unauthorized removal by the customer.
- 3) Damage caused by improper adjustment or unauthorized repair.
- 4) Damage caused by natural disasters such as earthquakes and floods.

Therefore, please operate the robot in strict accordance with the instructions in this manual and related manuals.

### 3, About help

For any questions or suggestions on the contents of the manual, you can query on the official website of the Elephant Robotics to submit the relevant information: <https://www.elephantrobotics.com>.

### 4, Contact information

- 1) Full name of company: Shenzhen Elephant Robotics Technology Co., Ltd.
- 2) Address: R208, B7, Yungu Innovative Industrial Park 2, Nanshan, Shenzhen, China 518057
- 3) Mail:
  - [Business Cooperation] [sales@elephantrobotics.com](mailto:sales@elephantrobotics.com)
  - [Promotional Cooperation] [marketing@elephantrobotics.com](mailto:marketing@elephantrobotics.com)
  - [Customer Service] [service@elephantrobotics.com](mailto:service@elephantrobotics.com)
  - [Technical Support] [support@elephantrobotics.com](mailto:support@elephantrobotics.com)
- 4) Tel: +86 755 8696 8565

# 1 Safety

## 1.1 Introduction

### 1, Introduction to this chapter

This chapter details general safety information for those who perform installation, maintenance, and repair work on the robot. Please read and understand the contents and precautions of this chapter before handling, installation and use.

According to ISO 10218, both robot manufacturers, system integrators, and individual users must perform hazard identification and risk assessment before using the robot. Conducting a hazard analysis can predict any hazards that may arise; and for hazards predicted in hazard identification, a risk assessment should be conducted to maximize personal safety and property safety.

This chapter provides a basic guide to safe use by introducing different safety alert symbols and precautions.

### 2, Interpretation of related terms

#### 1) Collaborative operation

A specially designed robot that works directly with people in a defined workspace.

#### 2) Collaborative workspace





In the safety protection space of the robot work unit, the robot and the person can complete the task at the same time in the production activity.

## 1.2 Safety alert symbol description

As shown in Table 1-1, this section describes the safety alert symbols used in this manual. You can find the corresponding symbols described in this chapter in other chapters, please note the meanings of these symbols.

Table1- 1 Safety Warning Symbol Table

 <p><b>Danger</b></p>	<p>Danger: Refers to a situation that is about to cause danger. Failure to avoid this can result in death or serious injury.</p>
--	--

 <b>Warning</b>	<p>Warning: Refers to situations that may cause danger. Failure to do so can result in personal injury or serious damage to the equipment.</p>
 <b>Caution Electricity</b>	<p>Caution Electricity: Refers to the use of electricity that may cause danger. If this situation is not avoided, it may result in personal injury or serious damage to the equipment.</p>
 <b>Prohibited</b>	<p>Prohibited: Refers to things that are not allowed to do.</p>
 <b>Attention</b>	<p>Attention: Refers to important matters that need attention.</p>

### 1.3 Hazard identification

The safety of collaborative robots is based on the premise of proper configuration and use of robots. Also, even if all safety instructions are observed, injury or damage caused by the operator may still occur. Therefore, it is important to understand the safety hazards of the use of robots, which is beneficial to prevent problems.

Tables 1-2~4 below are common safety hazards that may exist in the context of using robots:

Table1- 2 Dangerous safety hazards

 <b>Danger</b>	
1	<p>Personal injury or robot damage caused by incorrect operation during robot handling.</p>
2	<p>The robot was not fixed as required. For example, if the screw is not screwed or tightened, and the base is insufficient to stably support the robot for high-speed movement, etc., the robot may be dumped, etc.,</p>

	resulting in personal injury or damage to the robot.
3	The correct safety function configuration of the robot is not performed, or the safety protection tools are not installed, which causes the robot to fail to function safely, thus causing danger.

Table1- 3 Warning level security risks



 <b>Warning</b>	
1	Do not stay within the robot's range of motion when debugging the program. Unsuitable safety configurations may not avoid collisions that could cause personal injury.
2	Connecting robots to other equipment can create new risks and require a full risk assessment.
3	Scratches and stabs caused by sharp surfaces such as other equipment in the work environment or robot end effectors.
4	The robot is a precise machine, and pedaling may cause damage to the robot.
5	It is dangerous to hold the clamped object without clamping it in place or turning off the power and air supply to the robot (not sure if the end effector is firmly holding the object without falling off due to loss of power). It is dangerous to hold the clamped object without clamping it in place or turning off the power and air supply to the robot (not sure if the end effector is firmly holding the object without falling off due to loss of power).
6	There is a risk that the robot will move unexpectedly. Under no circumstances should you stand under any axis of the robot!
7	The robot is a precise machine. If it is not placed smoothly during handling, it may cause vibration and may cause damage to the internal components of the robot.
8	Compared with ordinary mechanical equipment, robots have more freedom and more range of motion. A narrow space that does not meet the range of motion may cause an unexpected collision.

Table1- 4 Potential safety hazards that may result in electric shock

 <b>Caution Electricity</b>	
1	Using a non-original cable may pose an unknown hazard.



2	Exposure to liquids with electrical equipment can result in a risk of electrical leakage.
3	There may be an electric shock hazard when the electrical connection is incorrect.
4	Be sure to replace it after turning off the power to the controller and related equipment and unplugging the power cord. If the work is performed while the power is on, it may cause electric shock or malfunction.

## 1.4 Safety Precautions

In general, compared with ordinary machinery, robots have the characteristics of larger working range and faster speed, which is accompanied by the danger that ordinary machinery does not have. When installing, using, and maintaining the robot, pay attention to the following items listed in Tables 1-5~6 (the followings are some of the common precautions listed):

Table1- 5 Safety precautions that need to be banned



 <b>Prohibited</b>	
1	It is forbidden to modify the robot or use non-original accessories.
2	Untrained non-professionals are prohibited from entering the robot work area at will, pressing any button or doing other operations at will.
3	The relevant personnel shall not maintain, repair or use the robot after being affected by drinking, taking drugs or stimulating drugs.

Table1- 6 General safety precautions

 <b>Attention</b>	
1	Anyone responsible for installing and maintaining the robot must read and follow these safety instructions. Only those who are familiar with robots and trained in robots are allowed to install and maintain the robot.
2	To protect the programmer, the operator, and the bystander, ensure that the safety measures have been established as defined in the risk assessment and that the robot safety parameters are properly configured.
3	Production operators should not loosen long hair (long hair must be picked

	up) and wear a work cap, not wearing a variety of jewelry.
4	Operators who work with the robot must be familiar with the content and exact location of the various warning signs and symbols on the device and ensure their integrity and clarity. Before turning the device on and off, make sure that all safety devices and related accessories are working properly and that no one is in a dangerous location where the device is activated. When the robot runs abnormally, it should stop immediately and report in time.
5	The operator must clarify the scope of responsibility for operation, commissioning, maintenance and repair. The operator is not allowed to change the operating procedures and teaching at will. No other personnel may enter the collaborative operation space and the danger zone.
6	During maintenance work, the warning sign must be hung to enter the collaborative operation space.
7	When the operator is in production, it should be ensured that each starting device is normal and is not allowed to start at will.
8	When the maintenance and operation personnel perform maintenance on the equipment, the main power switch must be turned off before maintenance work can be performed.
9	No objects should be stacked in the robot working area, and no debris should be stacked in the control box.
10	After the operation is completed, the gas and electricity switches should be closed according to the process, and the work site should be cleaned up.
11	It is forbidden to shake the robot hard and hang heavy objects on the robot.
12	All dangerous behaviors or games are prohibited around the robot.
13	After installing the robot, make sure the robot is fixed on a stable surface for subsequent operations.
14	It is important to ensure that the robot does not collide with itself or other objects during exercise.
15	If the robot is damaged, do not continue to use it and contact the relevant personnel for processing.
16	Please use the robot within the robot's parameter range and service life, otherwise it may cause serious safety problems.
17	After the emergency stop state is cancelled, the servo power must be turned on before the servo power supply is turned on again.
18	Please pay attention to the rotating shaft of the robot to prevent the cable and the air tube from being entangled. Keep a distance from the moving shaft to prevent hair or clothings from getting entangled.

19	Before using the drag teach function, make sure the load settings are correct.
20	When the robot is used with other equipment, please connect the emergency stop signal in series to stop the robot and other equipment in an emergency to avoid unnecessary loss.

## 1.5 Nameplate introduction

There are two types of nameplates used in the robot system, namely the nameplate of the robot body and the power box. The nameplate records some basic information about the product. It should be noted that the production number on the nameplate is unique. In other words, each product has a unique ID, which is an important basis for distinguishing each product, and is also important information to be provided when applying for repair.

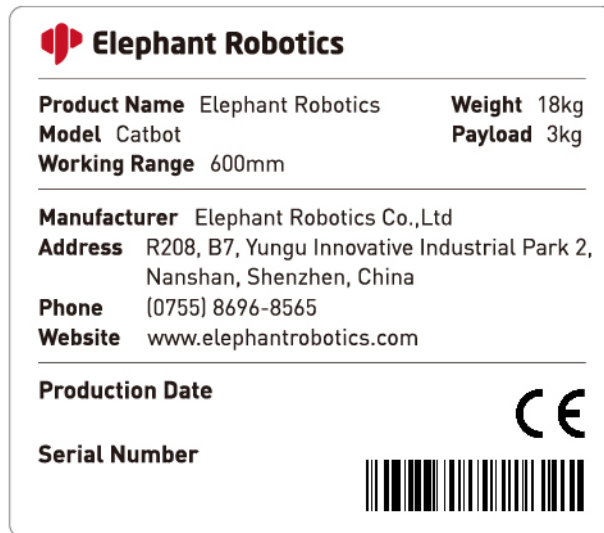

Figure 1- 1 Robot body nameplate

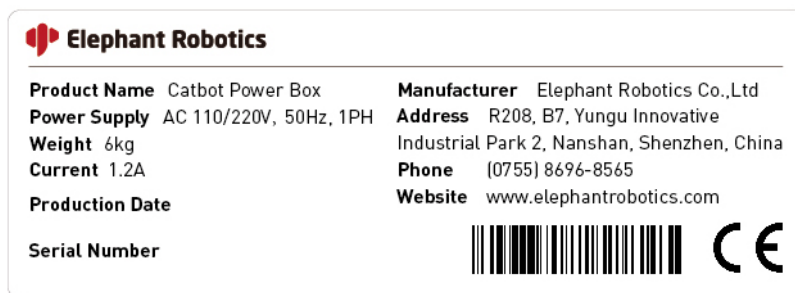

Figure 1- 2 Power box nameplate

## 1.6 Avoid misuse

Please do not use the Catbot series collaborative robot for the following purposes:

- Medical and life-critical applications.
- May cause an explosion in the environment.
- Used directly without risk assessment.
- Insufficient use of safety function levels.
- Inconsistent use of robot performance parameters.

## 1.7 Risk assessment guidance

Risk assessment is the whole process including risk analysis and risk assessment. National laws require risk assessment. It is recommended that integrators apply ISO 12000 and ISO 10218-2 for risk assessment of robots.

The risk analysis mainly includes:

- Determination of various limitations of the robot, including usage restrictions, space restrictions, and the like.
- Hazard identification, in addition to some of the hazard identification items listed above, users also need to carry out hazard identification according to actual use. For example, human-machine interactions during the life of the machine, possible states of the machine, unintended operator conditioning behaviors, or misuses that the machine can reasonably foresee.
- Risk estimation, analysis of risk factors (such as severity of injury, probability of injury, etc.), estimation of exposed personnel, protective measures, etc.

After completing the risk analysis, a risk assessment should be conducted to determine if a risk reduction is required.

## 1.8 Robot stop function

Each robot should have a protective stop function and a separate emergency stop function. This section describes two ways to stop the robot:

- If you want to stop the robot in an emergency, immediately press the emergency stop switch.
- When the force generated by the collision of the robot with the person or object is greater than the set threshold, the robot detects the force generated by the collision and stops or moves to a certain position (collision return).

### 1.8.1 Emergency stop

An emergency stop will cut off the drive source of the robot drive. At the same time, the hold-type brake will stop the inertial motion of the robot, the robot will stop all movements, and the running program will be stopped.

Do not press the emergency stop switch at will during normal operation. If the emergency stop switch is pressed during the action, the trajectory of the

robot before stopping will be different from the trajectory during normal operation, which may trigger an accident such as a collision.

When the vehicle is in an emergency stop state (normal), if the robot system is to be placed in an emergency stop state, press the emergency stop button when the robot does not operate.

Before using the emergency stop switch, you need to know the following:

- The emergency stop (E-STOP) can only be used to stop the robot in very urgent situations.
- The Catbot series collaborative robot has set up multiple emergency stops. In addition to the power box emergency stop button and the external emergency stop interface of the power supply box, an emergency stop interface is also provided on the robot body, and an emergency stop button box or a teach pendant can be connected (optional, the teach pendant is provided with an emergency stop button).
- The emergency stop button can only be manually reset, and before resetting, it is necessary to confirm that any other hazards that can be controlled by the robot have been eliminated.
- To stop the robot from running in a non-emergency situation, use the Pause command or the Stop command. These two commands do not turn off the motor. Therefore, the brake will not work.
- If you need to control the emergency stop of the robot and other equipment at the same time, you can use the external E-STOP double loop circuit (you need to short the circuit when it is not in use). This is a protective stop circuit that can be controlled manually or automatically.

### 1.8.2 Collision detection

During the operation of the robot, it is possible to come into contact with people or objects. It can be protected by setting a protection threshold. The specific mechanism of action is as follows: When the force generated by the collision of the robot with the person or the object is greater than the threshold, the robot detects the force generated by the collision, thereby stopping or moving to a certain position (collision return).

Please note that when the protection threshold is set too high, a large force is required to stop the robot, which will reduce the sensitivity of the collision detection to a certain extent; When the protection threshold is set too low, the robot may stop when it is holding the load due to the excessive torque generated by its own motion. Therefore, please set the threshold of protection under the guidance.

In addition to this, the user can set the protection threshold for each action and each movement of the robot.

## 1.9 Urgent handling



**Attention**

If the software jumps out of a fatal error message, activate the emergency stop quickly, write down the condition that caused the error, and contact your supplier.

In the event of a fire, use a carbon dioxide (CO<sub>2</sub>) fire extinguisher!

## 2 Product description

### 2.1 Robot system overview

The Catbot series collaborative robot is a 6-axis robot designed for business and education.

Generally, a traditional robot consists of three major parts: a robot body, a teach pendant, and a controller. As shown in Figure 2-1, the Catbot series collaborative robot use the latest integrated design. It solves the problem that the robot controller needs another land occupation for the first time and integrates the controller into the robot body to perfectly realize the cabinet integration. On the basis of accomplishing the same function, the advantages of convenient carrying, reducing space limitation and flexible arrangement are added.

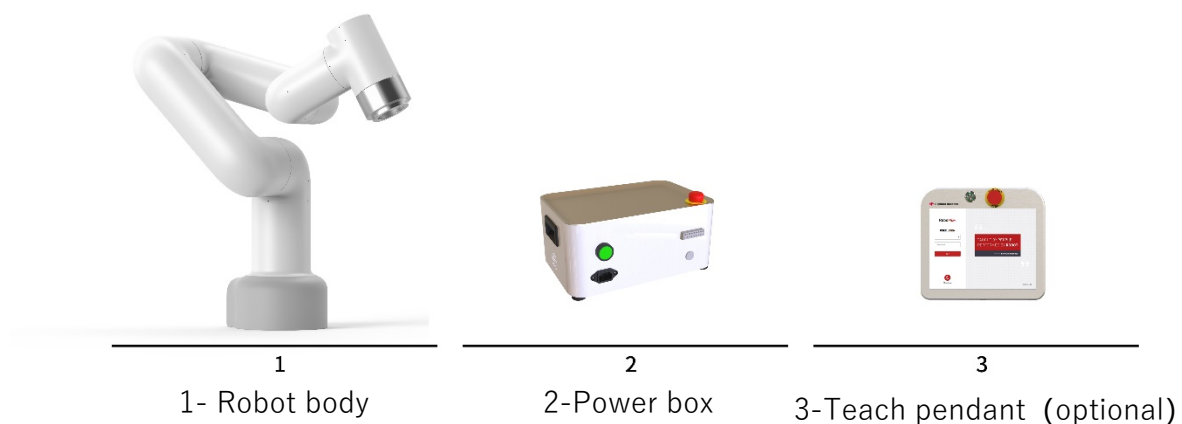

Figure 2- 1 Robot system

#### 1, The robot body

The robot body is a mechanical body used to complete various tasks of the robot system. It mainly includes the robot shell, drive unit, transmission unit and internal sensors. The main robot shell material is aluminum.

The robot's principle of motion is a combination of rotational motions of six joints. Using kinematics and dynamics analysis, the algorithm is solved to achieve the desired motion at the end of the robot.

The Catbot series collaborative robot also integrates the controller into the body. The controller is the main body that completes the robot control function and is a key part of determining the function and level of the robot. The main component is the computer, which controls the overall motion of the robot.

#### 2, The power box

A power box is used to power the robot body. It also sets an emergency stop button for user-friendly use.

#### 3, The teach pendant (optional)

The teach pendant is the main interface of human-computer interaction, and its internal part is composed of a touch screen, a display, a driving circuit board and some components. The robot can be programmed and operated by using a teach pendant.

In the Catbot series collaborative robot, the teach pendant is an optional accessory. Even without the teach pendant, the user can connect to the robot using other display devices, tablets, mobile phones, etc., to achieve related operations on the robot.

To put it simply, if the robot system is like a human, then the controller is like a human brain, controlling the robot body (like a human hand) to perform tasks, and the teach pendant is a human-computer interaction interface between the robot system and people.

## 2.2 The robot body

### 2.2.1 Feature

The Catbot series collaborative robot has the advantages of convenient carrying, easy installation, short deployment time, easy operation, safe use and convenient expansion of peripheral equipment, which can greatly shorten the deployment time of the factory for automation project transformation and reduce the total cost of deployment. The specific description is as follows:

#### 1, Cabinet integration

The Catbot series collaborative robot integrates the controller into the robot body to achieve cabinet integration. It has a modular design and a compact body with a body weight of only 18kg. This design also greatly reduces the overall footprint of the robot system, and can effectively simplify the installation steps of the robot and shorten the installation time.

The Catbot series collaborative robot can adapt to the structure of the production workshop, but also to the installation conditions of shops and studios in non-industrial environments.

#### 2, Voice control

In addition to the unique security of collaborative robots, the genie series of collaborative robots also added human-machine voice interaction. This is also a manifestation of the development of robotic AI, making the machine interaction more diversified. The user can directly talk to the robot, easily know the current running state of the robot, and use the voice command to control the robot to start or pause the running of the program, making the robot more convenient and efficient.

#### 3, Security collaboration

Based on the accurate kinetic model of the collision detection algorithm, the Catbot series collaborative robot will automatically stop in case of a slight



collision to ensure the safety of personnel. Users do not need to set a safety fence when using the Catbot series collaborative robot, which can be easily applied to light industry, commercial, scientific research and other occasions.

### 2.2.2 Joint introduction

Figure 2-2 shows the schematic diagram of the joint number of the Catbot series collaborative robot. The Catbot series collaborative robot is a 6-degree-of-freedom industrial robot consisting of six joints (axes) with joint numbers as shown.

The robot body of the Catbot series collaborative robot can be regarded as an open chain multi-link mechanism. The starting link is the base of the robot, the end link is connected to the end effector, and the adjacent links are connected by a joint (axis).

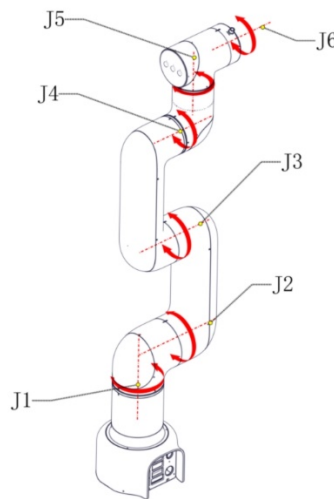

Figure 2- 2 Robot body joint numbering diagram

The flange at J6 can be used to connect end effectors such as electric actuators or end effectors such as pneumatic suction cups.

### 2.2.3 Dimensions

Figure 2-3 shows the outline of the robot body.

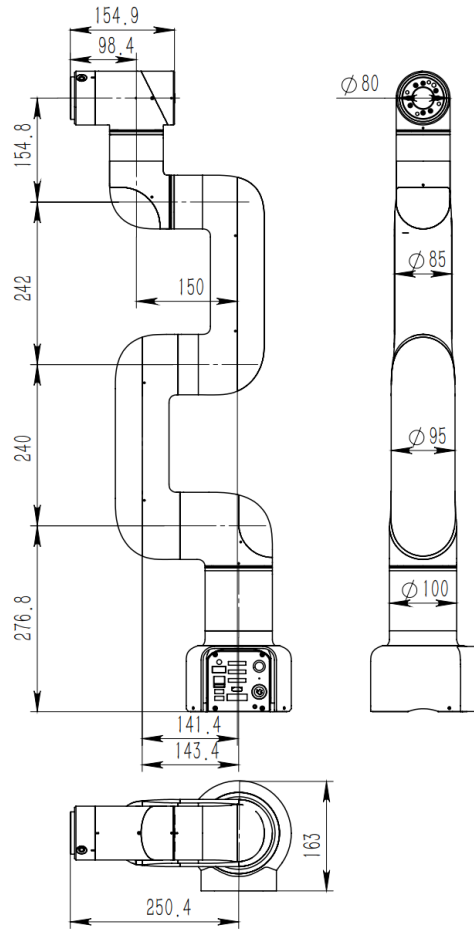

Figure 2- 3 Robot outline drawing

The span is the straight-line distance between the farthest point that the robot's wrist can reach and the centerline of the robot's base when the arm is extended horizontally to the maximum extent. The arm of the Catbot series collaborative robot is about 600mm.

### 2.2.4 Working range

Figure 2-4 shows the workspace of the Catbot series collaborative robot. Please limit the actual range of the robot according to the range of motion of the robot before using the robot to avoid the consequences of mismatch between the span and the actual motion space.

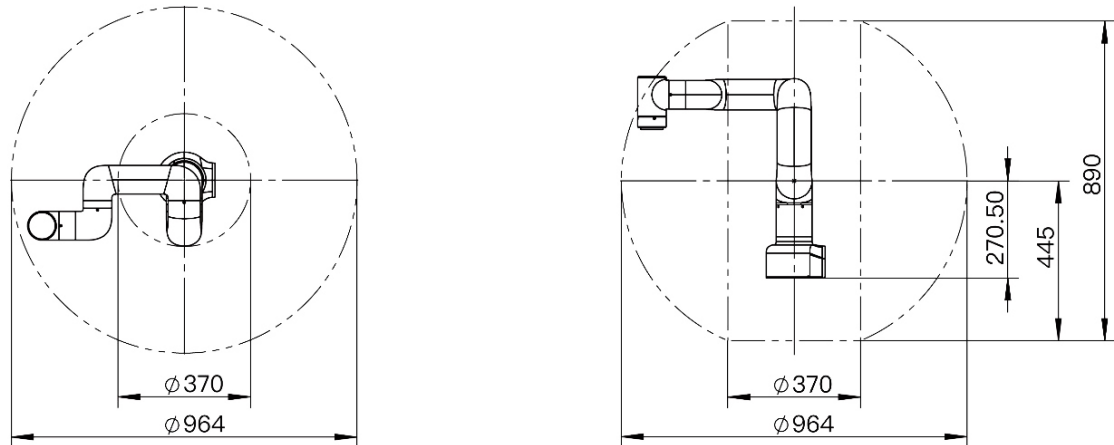

Figure 2- 4 Robot workspace diagram

### 2.2.5 Payload

The Catbot series collaborative robot has a rated load of 3kg and can work normally under load of 3kg and below. As the load moves further and further away from the J6 flange position, its payload will become smaller and smaller.

## 2.3 The power box

### 2.3.1 Power box composition

The main components of the power box are the switching power supply, the safety relay and the interface and buttons on the outside of the power box housing, as well as two handles and four foot cups.

### 2.3.2 Power box function

The main functions of the power supply box of the Catbot series collaborative robot are the safety function, the power supply function of the on-off body and the third-party power supply connection function.

#### 1, Safety features

The main electrical components in the power box that are closely related to safety functions are safety relays and emergency stop buttons.

The safety function mainly includes the user can cut off the power of the motor driver through the emergency stop button in an emergency; Once the emergency stop state is reached, after the emergency or related fault is removed, the user needs to manually reset the emergency stop button, and also needs to restore the motor driver power supply through software reset.

#### 2, On-off robot body power function

Make sure that the electrical connection is correct, the emergency stop button is released (ie, it has not been pressed, if it has been pressed, it can be turned clockwise), and the external emergency stop double circuit has been shorted, the user plugs the power box's plug into the socket. By turning on the

power button on the power box, the robot body can be successfully supplied with a safe voltage of DC 48V or less.

Reverse operation can cut off power to the robot body.

3, Third-party power transfer function

In some usage scenarios, the robot body does not require a power supply box to directly supply power, and only needs to be powered from other devices. For example, when the robot body is mounted on an AGV car, the user only needs to take power directly from the AGV car to supply power to the robot. Therefore, a dedicated third-party power supply interface is available on the power box.

2.3.3 Power box size

Figure 2-5 shows the external dimensions of the power supply box. When installing the robot, the user needs to determine the placement position by considering the external dimensions of the power box and the length of the power cord.

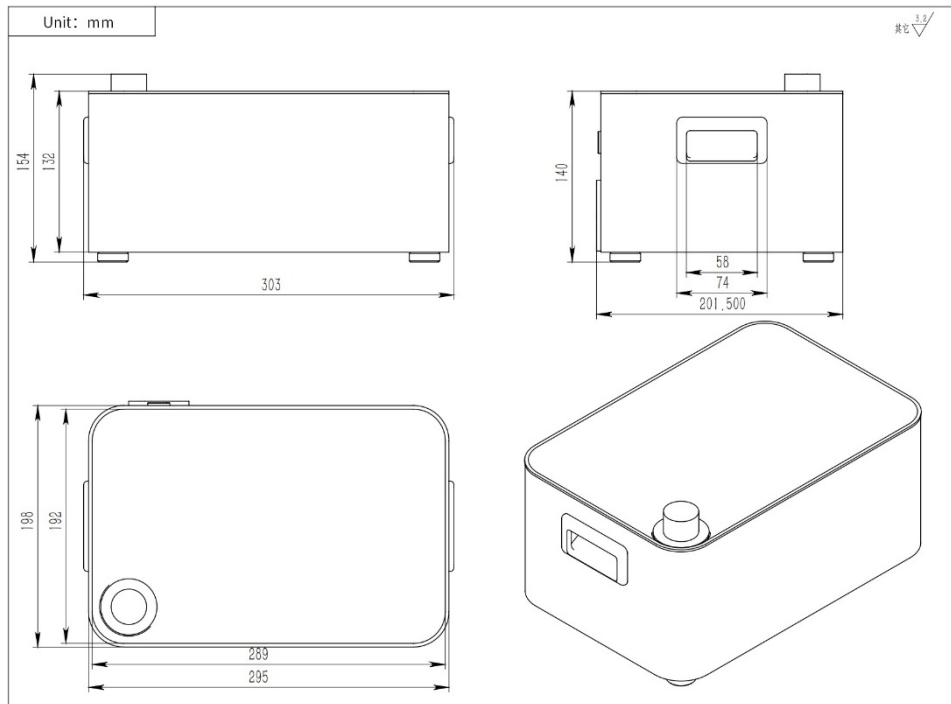

Figure 2- 5 Power box outline drawing

2.4 Technical parameter table

The specifications of the Catbot series collaborative robot are shown in Table 2-1.

Table 2- 1 Technical parameter table

<b>the Catbot series collaborative robot</b>	
Payload	3kg

Reach	600mm
Degrees of freedom	6
Working range	J1/J2/J4/J5/J6: $\pm 360^\circ$
	J3: $\pm 150^\circ$
Axis maximum speed	J1/J2/J3/ J4/J5/J6: 180°/sec
Tool speed	1m/sec
Weight	18kg
Position repeatability	$\pm 0.05\text{mm}$
Dimensions robot base	$\varnothing 150\text{mm}$
I/O ports	Digital Input:12
	Digital Output:8
Tool I/O ports	Digital Input:3
	Digital Output:3
I/O power supply	24V 1A
Communication	TCP/IP
Programming mode	Graphical programming
IP Rate	IP42
Power consumption	180W (Typical)
Materials	Aluminium alloy, PC, Rubber
Operating temperature range	0-50°C
Power supply	DC 48V, 10.5A
	DC 24V, 4.5A
Collaboration operation	Test in accordance with: EN ISO 13849-1:2015 EN ISO 10218-1: 2011
Noise	<70dB
Robot mounting	Any angle
Relative humidity	5%-95%
Interface and openness	SDK(Python, C++,JAVA),API,ROS
<b>Power box</b>	
Size (length × width × height)	303mm × 202mm × 154mm
Weight	6kg
Power supply	AC 220V, 50Hz
IP Rate	IP20
<b>Teach Pendant(Optional)</b>	

---

Size (length × width × height)	255mm × 230mm × 90mm
Weight	1.8kg
Screen resolution	1024×768
IP Rate	IP20
Touch screen / display size	10.4"

## 3 Environment and installation

### 3.1 Transportation and storage

Robots are precise equipment, so you need to pay special attention to the protection of the equipment when transporting.

 <b>Attention</b>	Avoid applying external force to the robot's outer casing and motor.
	When transporting the robot over long distances, secure it to the handling equipment to prevent the robot from tipping over. If necessary, use the package at the time of delivery.
	If condensation occurs during transport or storage, turn the power on after removing condensation.

When transporting before installation, lifting equipment such as driving should be used in principle. However, in view of the relatively light quality of the Catbot series collaborative robot, manual handling can also be considered without lifting equipment. Pay attention to safety when handling by hand and take it carefully to avoid damage to the equipment.

 <b>Attention</b>	It is necessary to prevent the machine from rolling over during handling and to avoid people standing around.
	When manually transporting the Catbot series collaborative robot, the number of personnel must not be less than two.
	The Catbot series collaborative robot is a precise device, so avoid excessive vibration and shock when handling.
	The weight of the Catbot series collaborative robot body is 18 kg.
	If lifting the robot by sling, in order to avoid damages, a thick pad is necessary to protect the outside appearance of the robot, and people should standing underneath the robot body when the robot is being lifted.
	The robot cable and power must be disconnected before handling.

Note that the robot storage environment temperature is 0-50 ° C, and it is dedicated to the person responsible for storage.

### 3.2 Unpacking inspection

After the package is in place, please confirm that the robot packaging is intact. If there is any damages, please contact the logistics company and the supplier in your area. As shown in Figure 3-1, the box of the Catbot series collaborative robot is a 720mm × 510mm × 420mm carton. The tank is equipped

with a cushioning filler to prevent excessive vibration and impact on the robot during transportation.

After unpacking, please check the actual items in the box according to the list of items. The list of items is shown in Table 3-1.

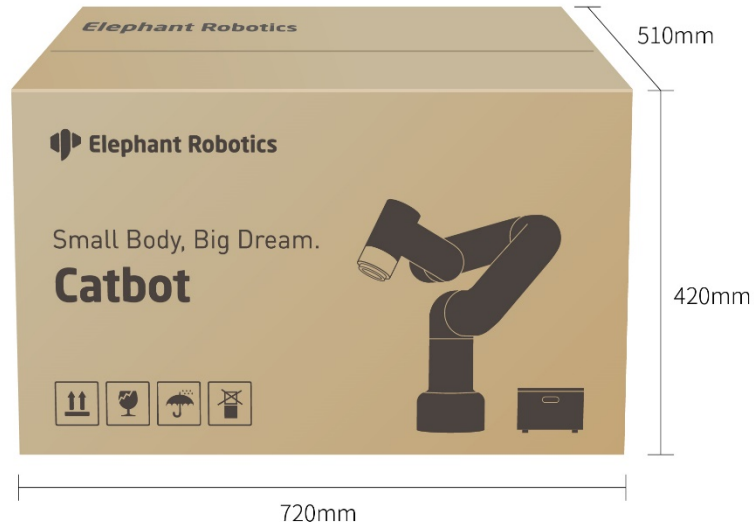

Figure 3- 1 Box size

Table 3- 1 List of items in the box

No.	Items	Quantity	Unit
1	Robot body	1	Pcs
2	Power box	1	Pcs
3	Power cable	1	Pcs
4	Body-power box cable	1	Pcs
5	Emergency stop button box (with cables)	1	Pcs
6	5mm hex wrench	1	Pcs
7	M6 × 20 socket head cap screws	4	Pcs
8	User manual	1	Pcs
9	Warranty card	1	Pcs
10	Factory report	1	Pcs
11	Product certification	1	Pcs

Take the robot out of the box and you can see the posture of the robot as shown in Figure 3-2. The side facing the reader is the upper side, and a movable buffer filler is stuck at the J6 flange (the position of the box is shown). When the robot body is taken out of the package, the filler needs to be removed.

If you need to put the robot back into the original box for transportation, you need to return the robot to the packing position. The data of each axis corresponding to the packing posture is shown in Table 3-2. Adjusting the robot



to the packing posture, you can manually operate each axis of the robot and adjust each axis to the target angle. You can also use the packaging function in the configuration center to control the robot to automatically reach the packing posture with one click.

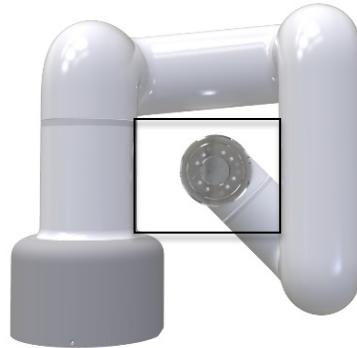



Figure 3- 2 Packing posture

Table 3- 2 Robot package posture data

Axis 1	90 °
Axis 2	-5 °
Axis 3	95°
Axis 4	45°
Axis 5	-180°
Axis 6	0°

 <b>Attention</b>	Please adjust the packing posture before removing the robot from the mounting base.
	Before making the package posture adjustment, make sure that the end effector and its cable are detached from the robot.
	If the user needs to adjust to another posture for transportation, in addition to manual adjustment of each axis angle, it can also be recorded into the program for subsequent use.
	Since the movement range of the robot to the packing posture is relatively large, during the adjustment process, please pay attention to the position of the robot to ensure that it will not cause accidental collision due to interference with peripheral equipment.

### 3.3 Working environment and conditions

Set the robot system in an environment that meets the conditions described in Table 3-3 to show and maintain the performance of the unit and use it safely.

Table 3- 3 Working environment and condition table

Temperature	0-50°C
Relative humidity	5%-95%
Indoor and outdoor requirements	Indoor
Other environmental requirements	<ul style="list-style-type: none"> <li>- Avoid sun exposure.</li> <li>- Keep away from dust, oil smoke, salt, iron filings, etc.</li> <li>- Keep away from flammable, corrosive liquids and gases.</li> <li>- Do not come into contact with water.</li> <li>- Do not transmit shock and vibration.</li> <li>- Keep away from sources of strong electromagnetic interference.</li> </ul>

## 3.4 Mechanical connection

### 3.4.1 Installation requirements

#### 1, Environmental requirements

The installation environment requirements are shown in Table 3-3.

#### 2, Mounting base

Considering that during the use, the center of gravity will change with the movement of the robot, so the user needs to fix the robot on the fixed base to be able to use normally. Users can use a fixed base or a movable base.

#### 3, Installation angle

Common installation angles for robots include vertical installation and inverted installation.

#### 4, Installation location

The installation location needs to be confirmed with a few points: Firstly, the range of motion of the robot target must not exceed the rated range of motion; secondly, make sure that the reserved space is sufficient for the robot to complete the target operation in the space; thirdly, make sure that there is enough space for installation, use, maintenance, and repair.

### 3.4.2 Mechanical connection step

#### 1, Confirm the robot base interface size

The fixing hole of the base is the interface for fixing the robot to the base of the machine base or the workstation. The specific hole size is shown in Figure 3-3. The base fixing hole position is 4 through holes with a diameter of 6.5 mm. The user can use the M6 bolts for fixing (M6 bolts and matching tools are already in the box).

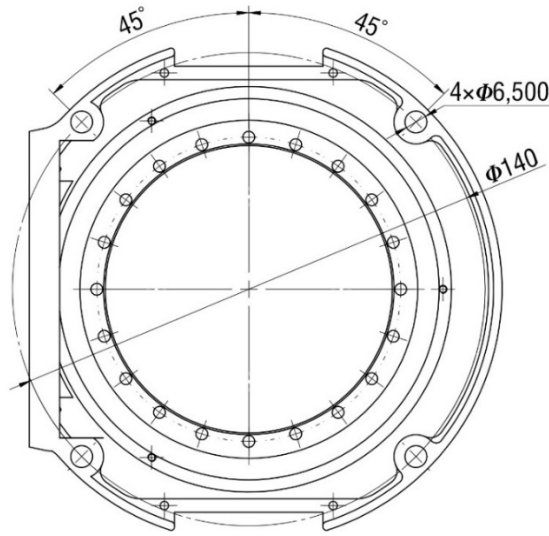

Figure 3- 3 Base fixing hole

The specific specifications of the fixing bolts are shown in Table 3-4.

Table 3- 4 Robot base fixing screw specifications

Bolt specification	M6
Bolt length	According to the platform thickness of the robot mounting base, but not shorter than 20mm
Strength	12.9
Tightening torque	12Nm ( a torque wrench for fastening is recommended)

2, Mount the robot on the base

Before you officially install, please confirm:

- Make sure that there is a corresponding threaded hole on the fixed base before proceeding the next installation.
- Place the base in the proper place
- Please make sure that the installation related tools are ready, such as screws and wrenches

After confirming the above, move the robot to the mounting surface of the base, pull up the base cover, adjust the position of the robot, and align the fixing hole of the robot base with the hole on the mounting surface of the base.

 <b>Warning</b>	When adjusting the position of the robot on the mounting base, try to avoid pushing the robot directly to avoid scratches.
	When manually transporting or moving the robot, try to avoid applying external force to sensitive parts of the robot body (such as

the motor) to avoid unnecessary damages to the robot.

After aligning the holes, align the bolts with the holes for installation. It is recommended that the installer first fix the bolts in the diagonal position and do not fully tighten them first, leaving a certain margin for easy adjustment of the other positions. After the all four bolts are in place, fully tighten them.

 <p><b>Danger</b></p>	<p>Once the robot is not yet securely mounted to the mounting base, the robot may be at risk of tipping at any time. Please keep the robot in balance.</p>
--	--

3, Place the power box, teach pendant

Figure 3-4 shows the installation of the Catbot series collaborative robot. Please determine the position according to the actual size of the power box and the cable orientation. If the user has purchased the teach pendant, it can be placed on the stand or hung to the self-installed hook.

 <p><b>Attention</b></p>	<p>When placing the robot power box, be careful not to keep its distance from the robot body beyond the length of the connecting cable.</p>
	<p>Select the proper place for the power box, try to avoid the power box being bumped or close to the wall, which may cause problems that may be unfavorable for heat dissipation.</p>
	<p>When selecting the place of the power box, make sure that dust and water can be avoided.</p>



Figure 3- 4 Installation diagram

4, Install the end effector to the robot J6 flange

End effectors are devices that are specifically designed and installed at the mechanical interface of the robot to perform tasks. For example, grippers, wrenches, welding torches, spray guns and etc. The specific flange size is shown in Figure 3-5.

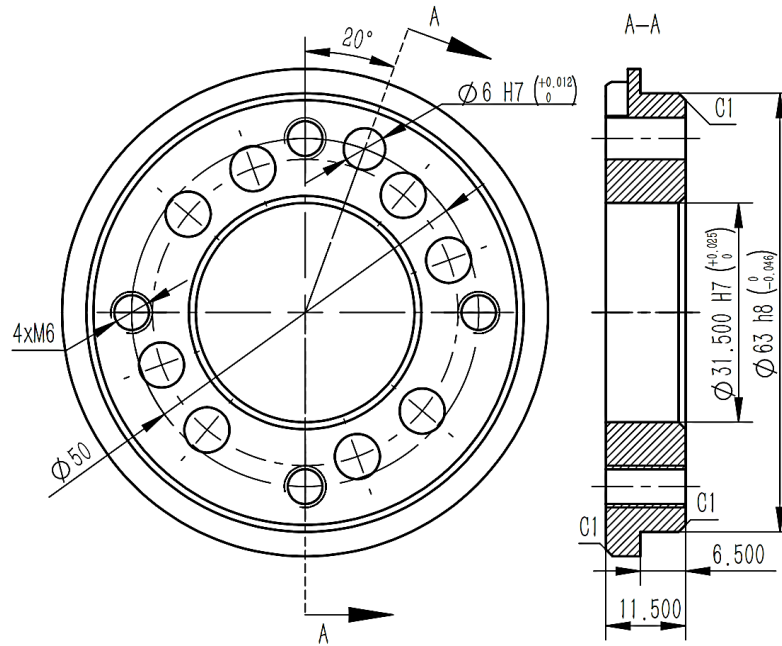

Figure 3- 5 Flange interface size

To install the end effector to the robot flange, there are two cases: one is that the interface of the end effector corresponds to the size of the mechanical interface of the flange; the other is to take the adapter with the size of the connection interface.

### 3.5 Electrical connections

#### 3.5.1 Electrical interface introduction

1, Power box interface and buttons

Figure 3-6 shows the power box interface and button.

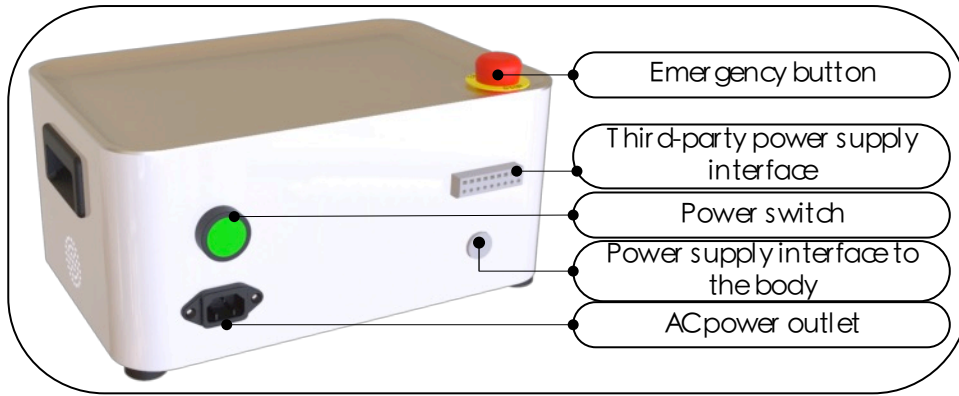

Figure 3- 6 Power box interface and button diagram

1) Emergency button

Press the emergency stop button to directly cut off the power of the motor drive. When the emergency stop event or fault is resolved, the emergency stop button can be turned clockwise to restore power.



Attention

The emergency stop button cuts off the power supply to the robot body, while the power box itself is still charged.

2) Third-party power supply interface

Figure 3-7 shows the definition of each interface. The third-party power supply interface is a single-row 9PIN terminal block.

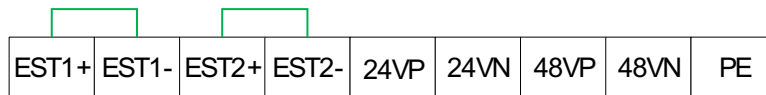

Figure 3- 7 Third-party power supply interface description

The first four interfaces "EST1+, EST1-, EST2+, EST2-" are external emergency stop interfaces. Among them, "EST1+, EST1-" is a loop, and "EST2+, EST2-" is another loop.

The fifth and sixth interfaces "24VP, 24VN" are the positive and negative poles of DC 24V, respectively. The seventh and eighth interfaces "48VP, 48VN" are the positive and negative poles of DC 48V, respectively. The ninth interface is the ground port.



Attention

The external emergency stop interface must remain normally closed. If there is no external emergency stop control device (such as external emergency stop button, automatic control device and etc.), you need to use jumpers to short the two emergency stop circuits "EST1+, EST1-" and "EST2+, EST2-".

3) Power button

If the power cord is connected to an AC 220V power outlet, press the power button to power the power box. Conversely, press the button again to turn off the power supply.

4) Power supply interface to the body

This interface is used to connect the power supply box and the robot body to supply power to the robot body. The corresponding interface definition diagram is shown in Figure 3-8.

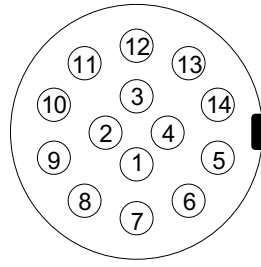

FRONT VIEW

Figure 3- 8 Power supply interface diagram for the body

The specific definition of this interface is shown in Table 3-5.

Table 3- 5 Definition the power supply interface for the body

No.	Signal	Explanation
1	E2+	Emergency stop circuit 2 input.
2	E1-	Emergency stop circuit 1 output.
3	E1+	Emergency stop circuit 1 input.
4	E2-	Emergency stop circuit 2 output.
5/6	48VN	DC 48V power supply negative.
7	PE	Ground terminal.
8	CTR	The robot powers up the control terminal
9	RST	The robot resets the control terminal.
10	EIN	Robot emergency stop signal input.
11	24VN	DC 24V power supply negative.
12	24VP	DC 24V power supply positive.
13/14	48VP	DC 48V power supply positive.

5) Power outlet

As shown in Figure 3-9, it is the power socket interface definition map. It is used to connect the AC 220V power cord. In the figure, "L, N, PE" respectively indicate the hot line end, the neutral line end, and the ground end.

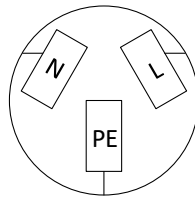

Figure 3- 9 Power socket interface definition diagram

2, Body base interface panel

For user convenience, the Catbot series collaborative robot provides a variety of interfaces. Figure 3-10 shows the definition of each interface of the body base interface panel.

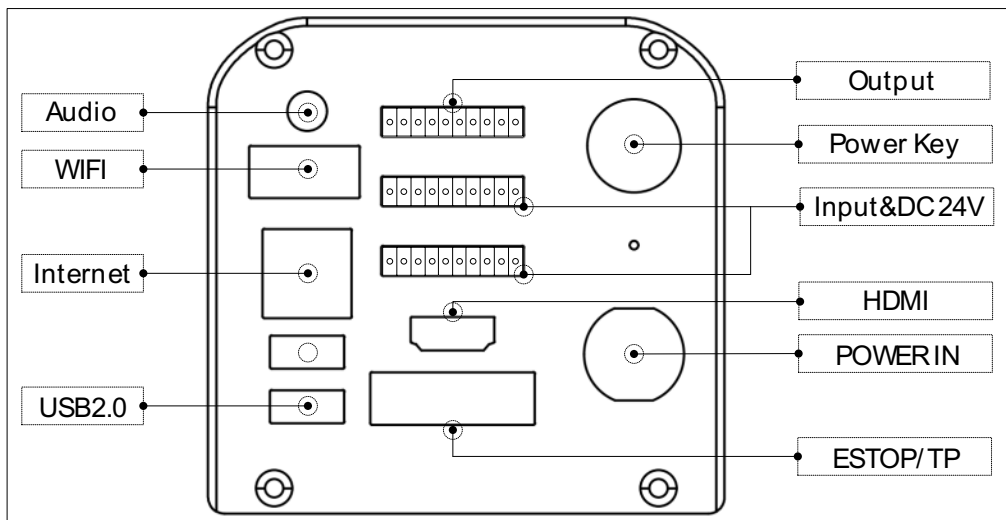

Figure 3- 10 Body base interface definition diagram

- 1) Audio interface: system audio interface.
- 2) Wireless WiFi interface: connect to wireless WiFi
- 3) Ethernet interface: the port of the network data connection
- 4) USB 2.0 interface: a port for data connection using the serial bus standard USB 2.0
- 5) Digital output Interface

As shown in Figure 3-11, the output is an NPN output. When the control signal is high, the triode is activated, and the output is turned on with GND. When the control signal is low, the triode is blocked, and the output is in a floating state.



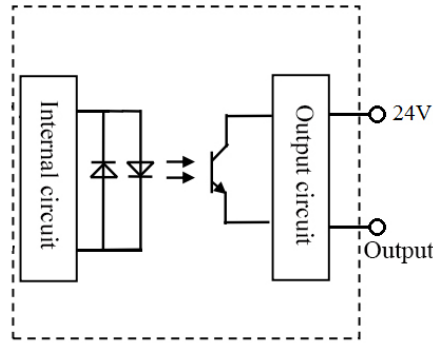

Figure 3- 11 Output schematic

As shown in Figure 3-12, the first two bits of the output interface are DC 24V power supply positive, and the rest are OUT0~OUT7 for a total of 8 general-purpose output interfaces. The maximum output current of each channel is 300mA.

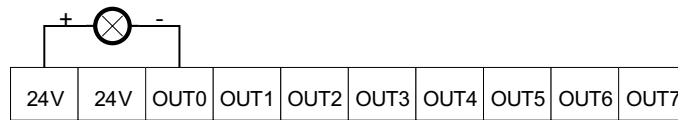

Figure 3- 12 Output interface definition diagram

Take the output control indicator on or off as an example in Figure 3-12. The positive indicator is connected to the positive DC 24V power supply, and the negative indicator is connected to OUT0 or other output interface. When the output signal is off, OUT0 is high and the light is off; when the output signal is on, OUT0 is low and the light is on.



Attention

The "24V" shown in Figure 3-12 is actually connected to the "24V" in Figure 3-14. Therefore, when connecting the positive pole of the output signal loop, **all of** these DC 24V positive terminals can be used.

6) Power button: The robot system power button. If the power is connected, press the button to start the system.

7) Digital input & 24V power connector

As shown in Figure 3-13, the input signal drives the optocoupler through the current-limiting resistor R, allowing the internal circuit to detect it. The difference between the PNP input and the NPN input is that one end of the PNP input is connected to 0V, and one end of the NPN input is connected to 24V.

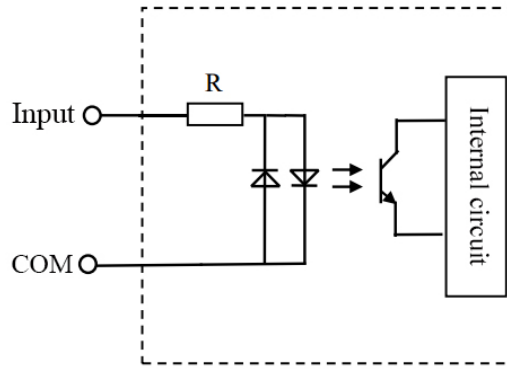

Figure 3- 13 Input schematic

Figure 3-14 shows the digital input & 24V power interface definition. Divided into two rows, a total of four groups.

- The first group is the two positive ports and three negative ports of the DC 24V power supply.
- The second group is the four universal input interfaces IN8~IN11 and their common terminals.
- The third group is the four universal input interfaces IN0~ IN3 and their common terminals.
- The fourth group is the four general input interfaces of IN4~IN7 and their common ends.

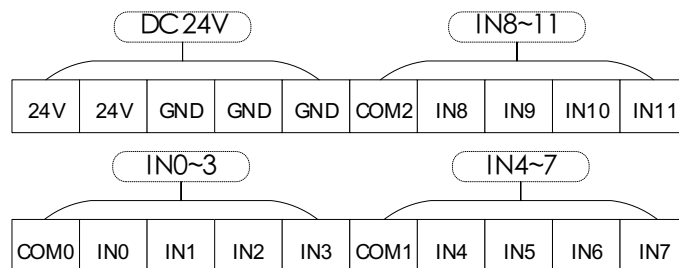

Figure 3- 14 Input & 24V power interface definition diagram

The input signal can be determined to be active high or active low depending on the configuration of the input common.

As shown in Figure 3-15, if the input common terminal is connected to the DC 24V positive pole, the input device (taking the switch button as an example) is connected to the DC 24V negative terminal and the other terminal to the input port. Pressing the switch button at this time will input a valid signal.

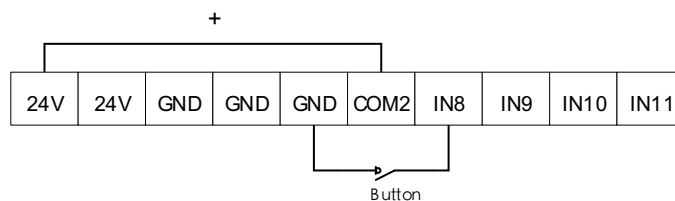

Figure 3- 15 Common access to high level example

As shown in Figure 3-16, the input common terminal can also be connected

to the DC 24V negative pole. The input device (taking the switch button as an example) has one end connected to the DC 24V positive pole and the other end connected to the input port. Pressing the switch will input a valid signal.

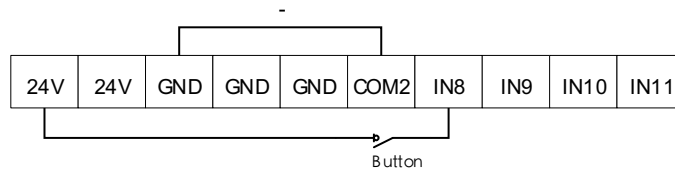

Figure 3- 16 Common access low example

8) HDMI display interface

When the teach pendant is not equipped while the robot operation page is displayed, the user can display the operation page to other device terminals by connecting the HDMI display interface.

If a teach pendant is already installed, the user needs to connect the Teach Pendant HDMI cable to this connector.

9) Body power supply interface

This interface and the power supply box connect the power supply interface of the main unit through the power line, as shown in Figure 3-17. The definition is the same as the corresponding interface of the power supply box. See Table 3-5 for specific definitions.

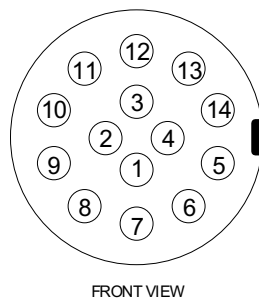

FRONT VIEW

Figure 3- 17 Body power supply interface diagram

10) Emergency stop box / teach pendant interface

The port sequence of the emergency stop box/teacher interface is shown in Figure 3-18. When the teach pendant is not equipped, this interface needs to be connected to the emergency stop button box. If equipped with a teach pendant, this interface is connected to the teach pendant cable.

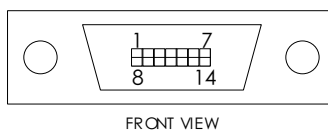

FRONT VIEW

Figure 3- 18 Emergency stop box / teach pendant interface diagram

The detailed definition of the the interface of both emergency stop box and teach pendant is shown in Table 3-6.

Table 3- 6 Definition of the interface of emergency stop box / teach pendant

No.	Signal	Explanation
1	GND	DC 12V negative electrode.
2	PWR_LED	The positive side of the ring light on the teach pendant button.
3	PWR_KEY	One end of the teach pendant button (the other end is connected to GND).
4	EST2-	Emergency stop circuit 2 output.
5	EST2+	Emergency stop circuit 2 input.
6	EST1-	Emergency stop circuit 1 output.
7	EST1+	Emergency stop circuit 1 input.
8	GND	DC 12V negative electrode.
9	12V	DC 12V positive.
10	NC	Unused.
11	GND	DC 12V negative electrode.
12	GND	DC 12V negative electrode.
13	RS232 TXD	RS232 serial communication transmits the data terminal.
14	RS232 RXD	RS232 serial communication receives the data terminal.



**Attention**

Since this interface has an emergency stop dual-circuit interface related to the emergency stop circuit, this interface must be installed in place to connect the emergency stop button box or the teach pendant in order to make the robot function normally.

### 3, Function button

Figure 3-19 shows the function button diagram. The button panel is installed in the J6 position. The functions of the three buttons from left to right are to start (press again to pause) the program running button, stop the program running button and customize the button.

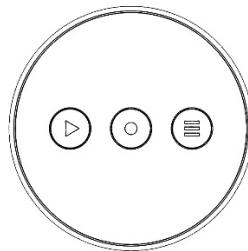

Figure 3- 19 Function button diagram

### 4, Tool I/O

Figure 3-20 shows the tool I/O diagram. The Catbot series collaborative

robot provides 3 inputs and 3 outputs.

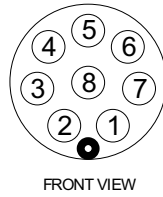

Figure 3- 20 Tool I/O diagram

The definition of each tool I/O port is shown in Table 3-7. Unlike the principle definition of general-purpose I/O, the tool I/O is PNP type regardless of input or output, that is, the device I/O connected device is connected to GND at one end, and the control terminal is connected to the I/O port.

Table 3- 7 Tool I/O definition

No.	Signal	Explanation
1	GND	DC 24V negative electrode.
2	24V	DC 24V positive.
3	OUT1	Tool output interface 1~3.
4	OUT2	
5	OUT3	
6	IN1	Tool input interface 1~3.
7	IN2	
8	IN3	

### 3.5.2 Cable connection

There are three main cables in the robot system. Among them, if the user has not equipped the teaching device, the third is the emergency stop box cable; otherwise, the teach pendant cable. The specific information is shown in Table 3-8.

Table 3- 8 Robot main cables

Type	connection	length	Use description
AC power cord	External AC power supply - power supply box	2m	Power the entire robot system.
Power cable	Robot body - power box	3m	Power the robot body.
Option 1 - Emergency stop box line	Robot body - emergency stop box	3m	If the user does not configure the teach pendant, an emergency stop box will be configured.

Option 2 – Teach pendant Cable	Robot body - teach pendant	4m	Connect the robot body and the teach pendant.
--------------------------------	----------------------------	----	---

The AC power cord is used to connect an AC 220V power outlet to a power box. The power cable is connected to the power box and the robot body. If the user does not purchase the teach pendant, there is also an emergency stop box cable that needs to be connected to the robot body; If the user has a teach pendant, connect the teach pendant cable to the robot body at the same interface position of the emergency stop cable connector.

 <b>Attention</b>	The original cable must be used.
	The cable interface is generally easy to be damaged. Do not use brute force or vigorously shake when plugging or unplugging. It is easy to cause the interface to be loose or deformed. Please insert and remove it carefully after alignment.

 <b>Caution Electricity</b>	Be sure to replace the power supply box and related equipment after removing the power supply and unplugging the power supply. If the work is performed while the power is on, it may cause electric shock or malfunction.
	Be sure to connect the AC power cable to the power plug and not directly to the factory power source. Turn off the power to the robot system by unplugging the power cord. It is extremely dangerous to work when the AC power cable is connected to the factory power supply, which may result in electric shock and malfunction of the robot system.
	Be careful not to bend the cable forcibly to avoid applying a load to the cable. Also, do not place heavy objects on the cable and forcibly bend or pull the cable. Failure to do so may result in damage to the cable, disconnection, or poor contact, resulting in electric shock or improper system operation.
	Before wiring, turn off the power supply box and related equipment and pull up the warning sign (for example, do not turn on the power). Wiring in an energized state is extremely dangerous and may result in electric shock and malfunction of the robot system.
	Please ensure that the ground wire connection is reliable, otherwise it may cause fire or electric shock.

### 3.6 System startup debugging

After the installation and connection work is completed, please plug in the

power cord, turn on the power switch, press the system start button of the teach pendant, observe whether the display button of the teach pendant is lit, and the light indicates that the installation is successful, you can enter the next step; If it does not light up, you need to check whether an important step is missing. If you have failed to check the manual several times, it may cause a malfunction during transportation. Do not disassemble the parts yourself. Please contact a professional for disposal.

Figure 3-21 shows the startup flowchart of the robot system. Please strictly follow the manual, otherwise the warranty will not be available if the robot is damaged due to improper operation.

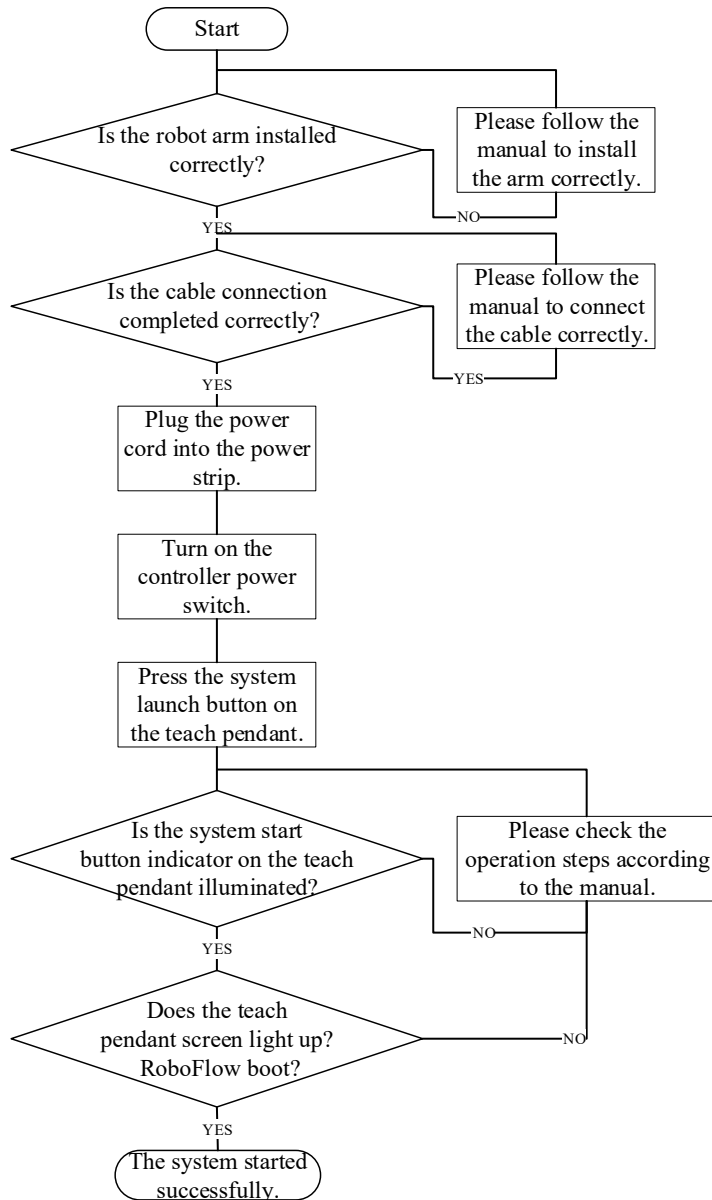

Figure 3- 21 Robot system boot flow chart

# 4 Maintenance

## 4.1 About the safety of maintenance

After the robot has been running for a period of time, necessary maintenance is required to ensure that the robot is functioning properly. Please contact a professional:

- Make sure to perform robot maintenance by trained personnel.
- Personnel trained in safety refer to those that have been regulated by national laws and regulations.
- Personnel who are trained in the safety of workers engaged in industrial robot-related business (training on knowledge, operation, teaching and etc. of industrial robots, knowledge of business operations such as inspections, and related laws and regulations).
- The company's maintenance targets are those who have completed the training and maintenance training.

Before maintenance, please read “Safety in Maintenance”, this manual and related manual, and perform maintenance based on a thorough understanding of safety maintenance methods.

 <b>Warning</b>	Do not change any information in the software security configuration (such as force limits). If the safety parameters change, the entire robot system should be considered a new system, which means that all safety audit processes, such as risk assessment, must be updated.
	Do not remove any parts unless otherwise stated in this manual. The maintenance steps are strictly adhered to according to the content. If the wrong disassembly or maintenance is performed, not only will the robot system malfunction, but it may also cause serious safety problems.
	Be sure to check the robot movement after replacing the parts outside the safety fence. Otherwise, the robot before the action confirmation may perform unexpected actions and may cause serious safety problems.
	All disassembled robots need to be recalibrated.
	If you have not received training, stay away from the robot when the power is on. Also, do not enter the action area. Even if you see that the robot seems to stop moving, the robot that is powered on may accidentally operate and may cause serious safety problems.
Before entering the normal operation, please confirm that the	



emergency stop button and the safety guard button are in normal operation. If the button does not operate normally, the safety function cannot be performed in an emergency, which may result in serious injury or serious damage, which is very dangerous.

 <b>Caution Electricity</b>	Be sure to perform maintenance, replacement, and wiring work after turning off the power supply box and related equipment and unplugging the power cord. Failure to do so may result in electric shock or malfunction.
---	--

## 4.2 Maintenance plan

In order to maintain efficient performance over the long term, regular maintenance of the robot is required. The maintenance personnel must prepare an overhaul plan and strictly implement it. The recommended maintenance schedule is shown in Table 4-1.

Table 4- 1 Maintenance schedule

No.	Task	Device	Daily	1 month	3 month	6 month	12 month	
1	Check	Robot appearance	√					
2		Cable interface		√				
3		Cable harnesses	External		√			
4			Internal				√	
5		Screw	Surface		√			
6			Internal				√	
7	Clean	Robot whole	√					
8	Replace	lubricating oil	Replace when the gear unit needs to be replaced.					

## 4.3 People who can be contacted

1, System integrator

You can directly contact the system integrator responsible for installing and debugging the Catbot series collaborative robot.

2, Supplier

You can contact Elephant Robotics' supplier in your area. For specific supplier information, please visit the official website: [www.elephantrobotics.com](http://www.elephantrobotics.com).

3, Official website

You can find out more information by visiting the official website of Elephant Robotics ([www.elephantrobotics.com](http://www.elephantrobotics.com)).

## 5 Repair

When the robot malfunctions, do not continue to operate it. Immediately contact the operator who has received the prescribed training to perform fault analysis and check out which components are being abnormal.

The repair, inspection, adjustment and etc. of the robot must be carried out by an authorized system integrator or agent. Please contact a professional for disposal. Do not disassemble the robot at will. See section 4.3 for contact details.

When contacting, please prepare the following items in advance:

- Power box name, serial number.
- Robot name, serial number.
- Description of the problem (additional pictures are appreciated).